

C100 with low backrest

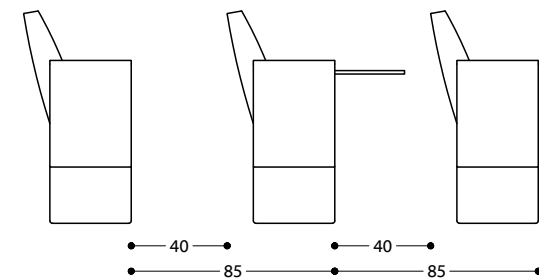

C100 with low backrest

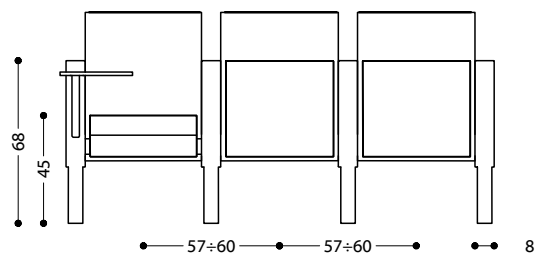
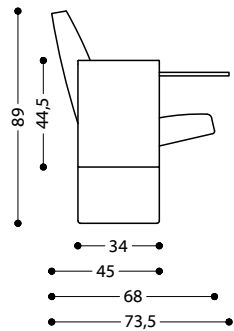
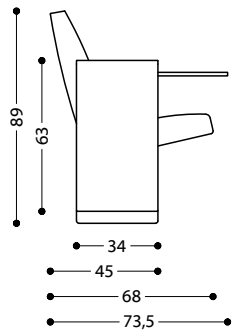
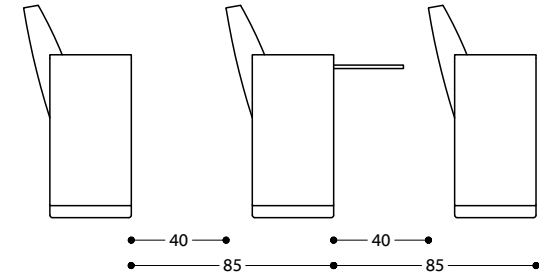
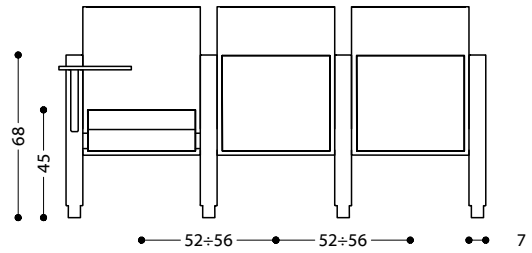
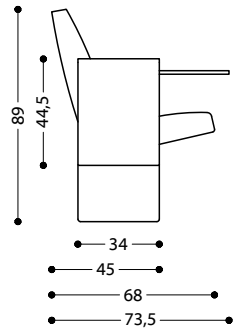
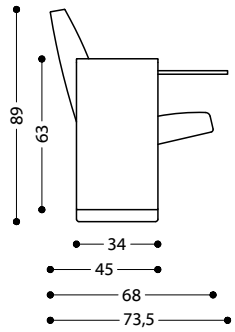
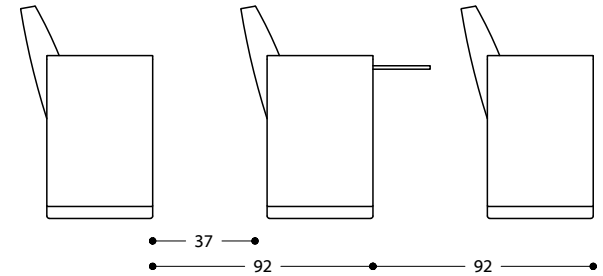
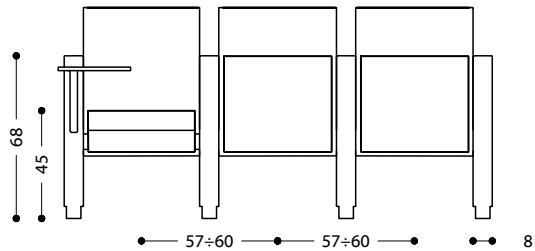
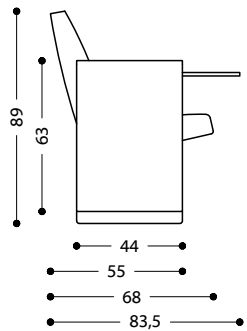
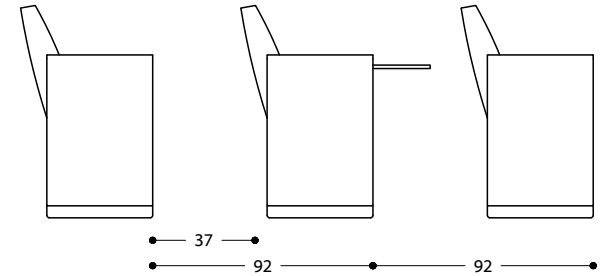
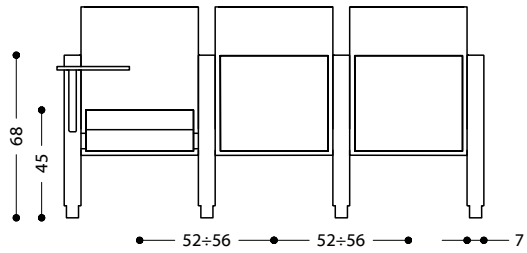
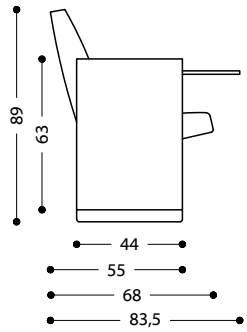

C100 with low backrest

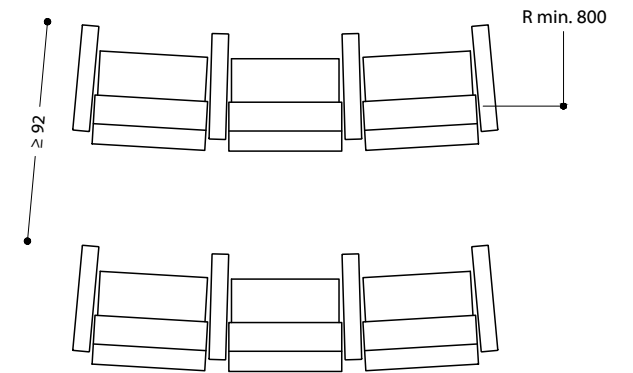
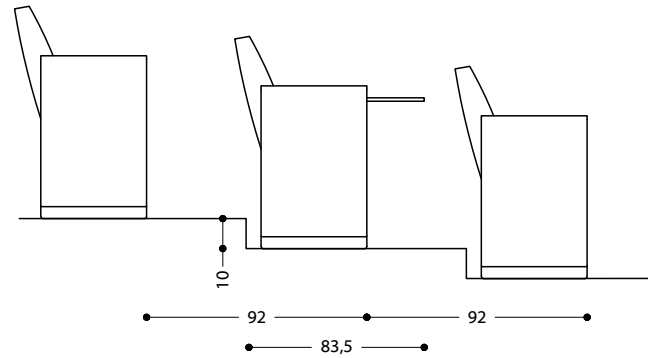

C100 with high backrest

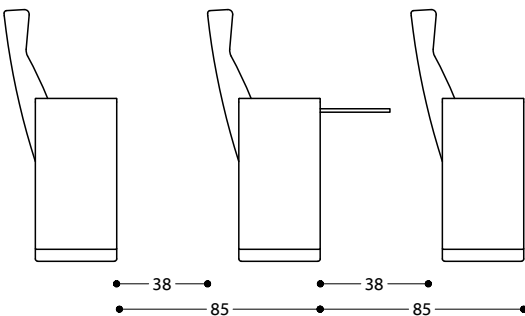
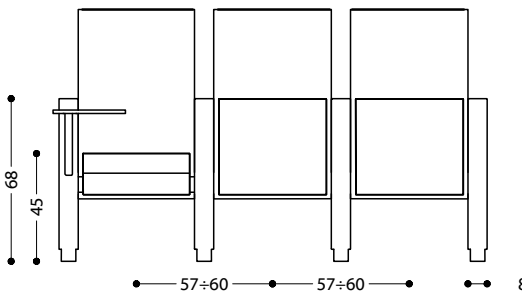
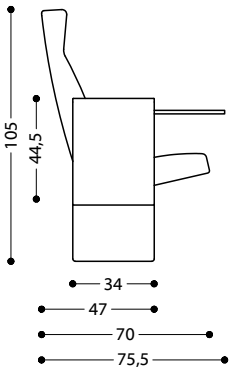
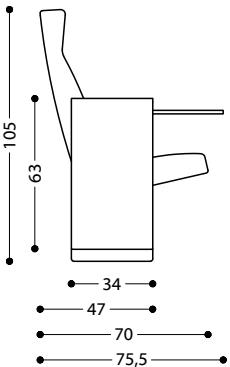
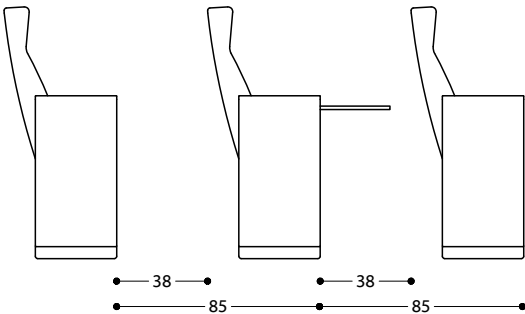
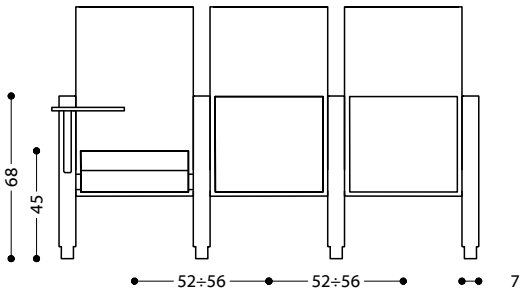
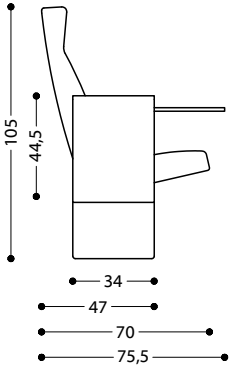
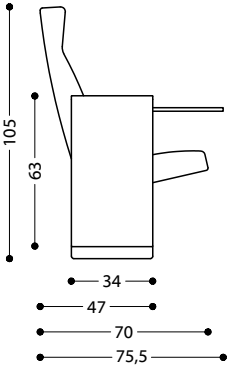

C100 with high backrest + T200 table

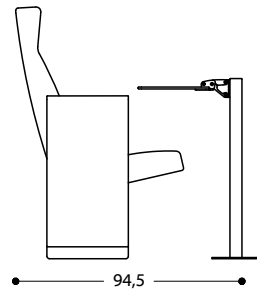
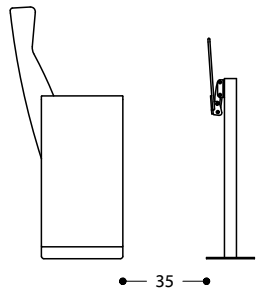
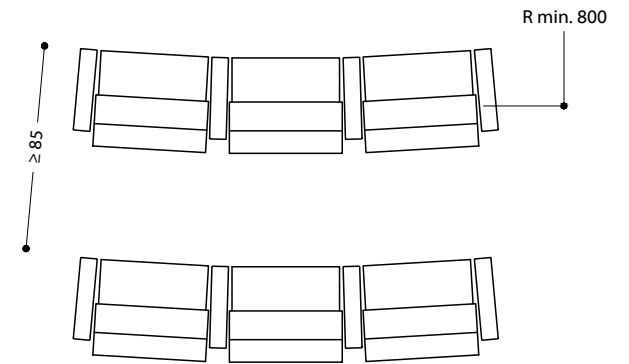
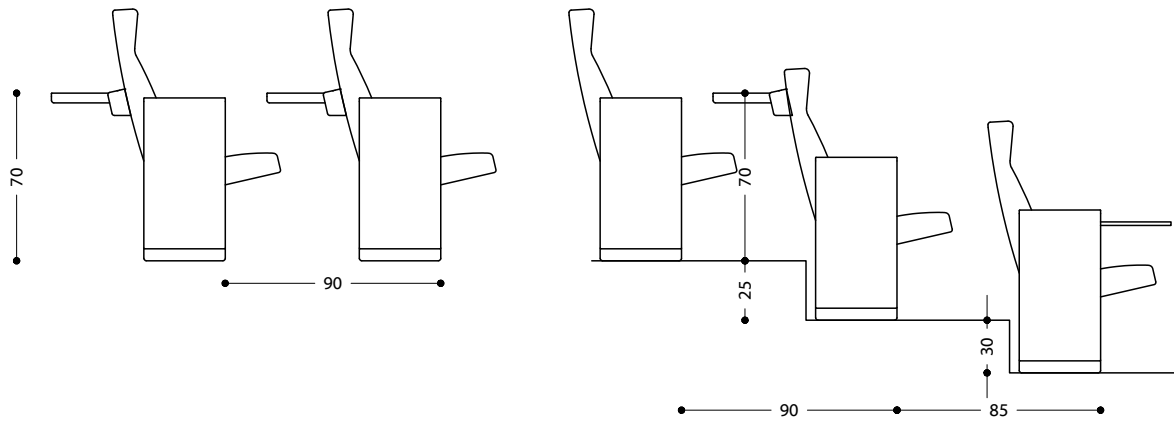

C100 with high backrest

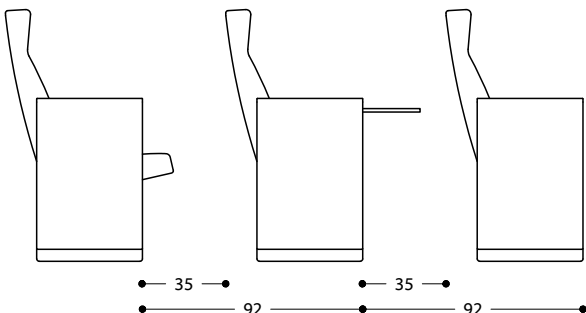
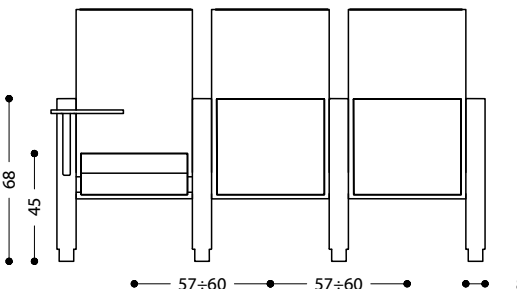
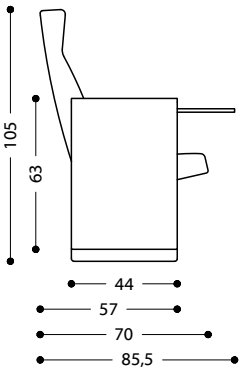
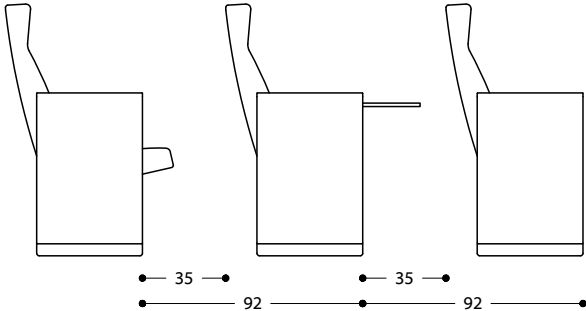
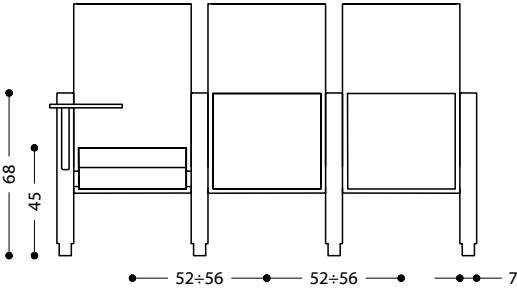
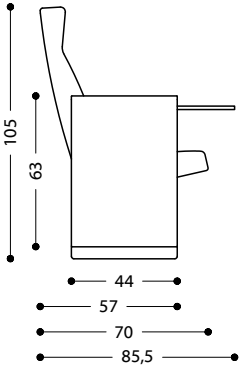

C100 with high backrest

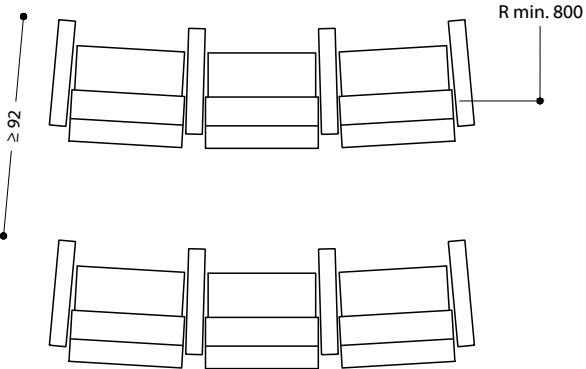
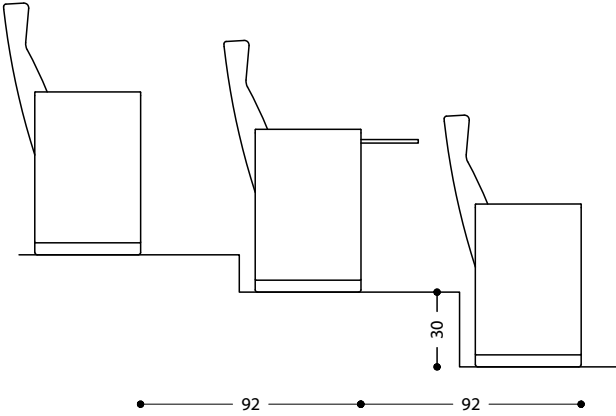

C100 with low backrest

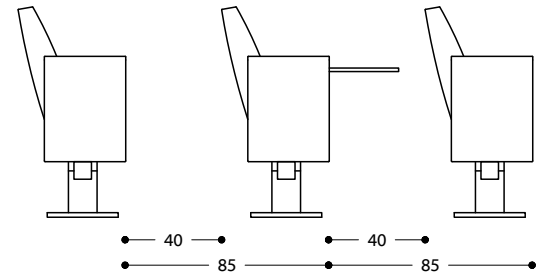
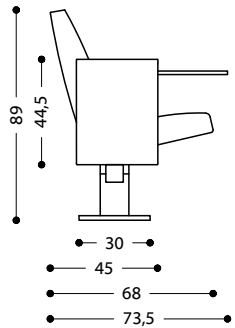
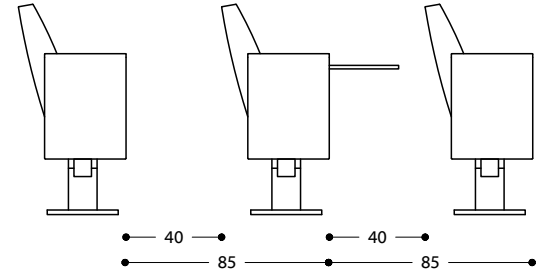
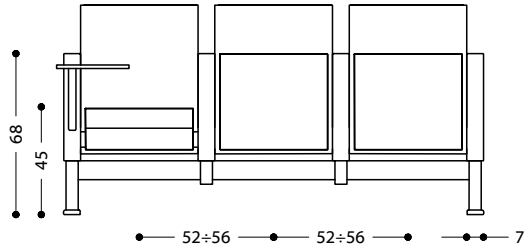
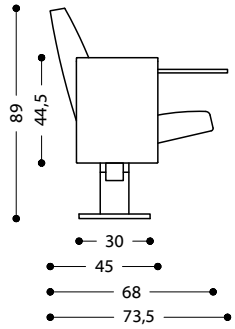

C100 with low backrest + T200 table

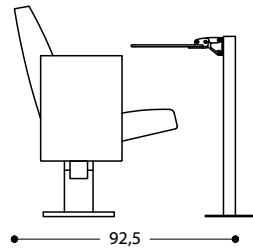
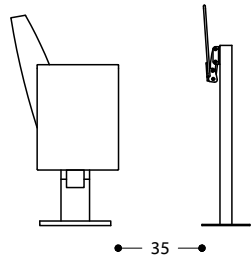

C100 with low backrest

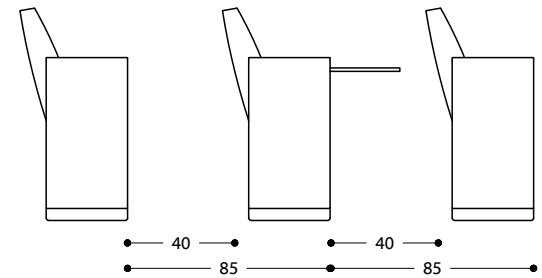
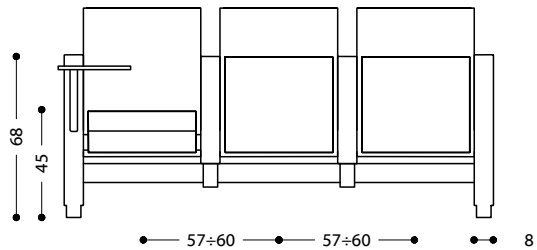
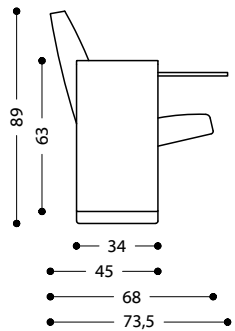
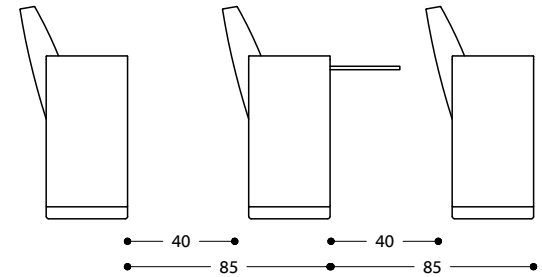
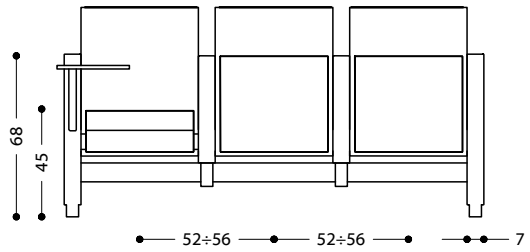
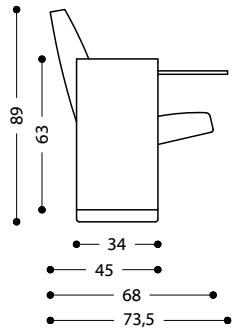

C100 with low backrest

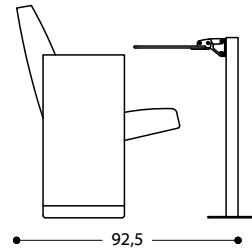
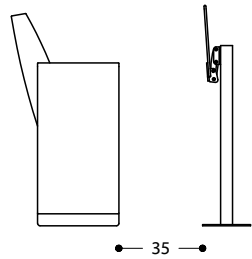

C100 with high backrest

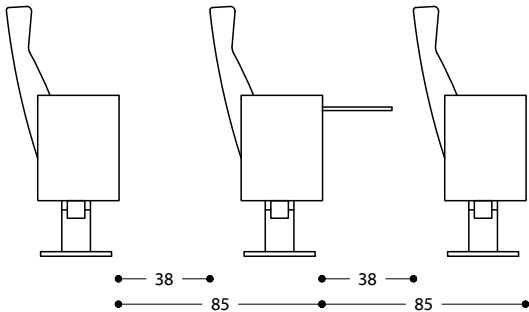
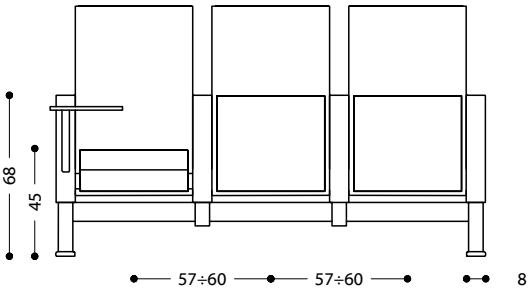
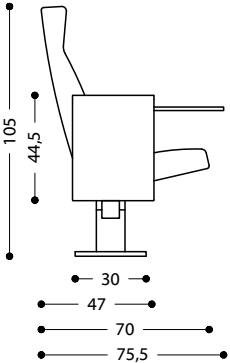
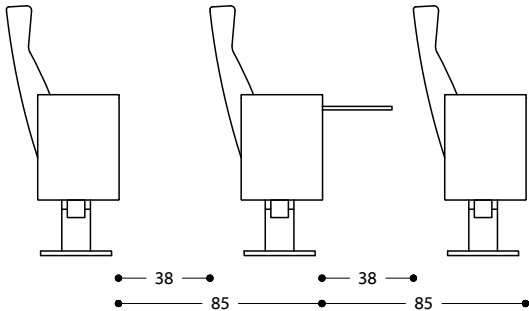
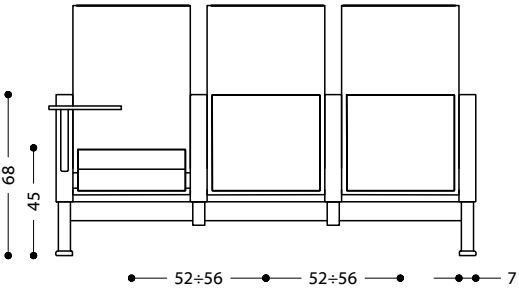
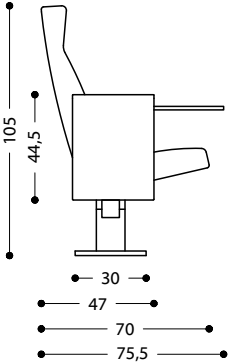

C100 with high backrest + T200 table

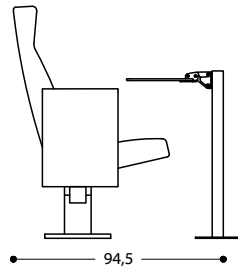
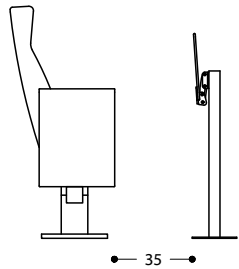

C100 with high backrest

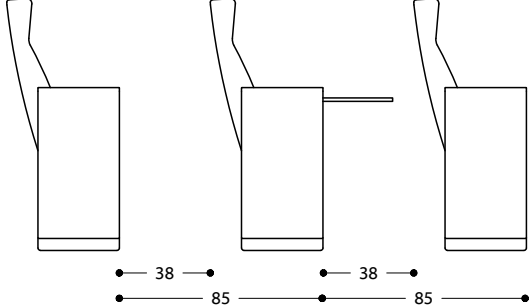
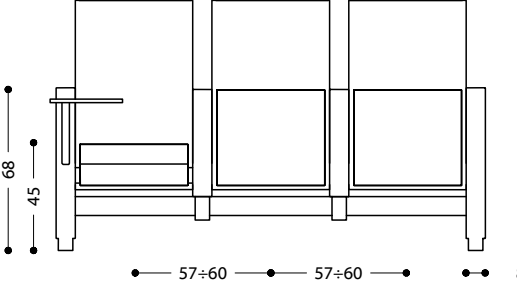
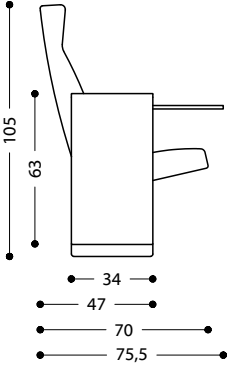
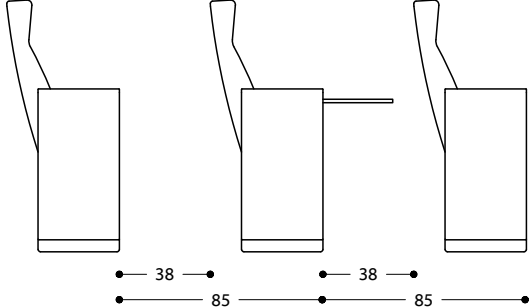
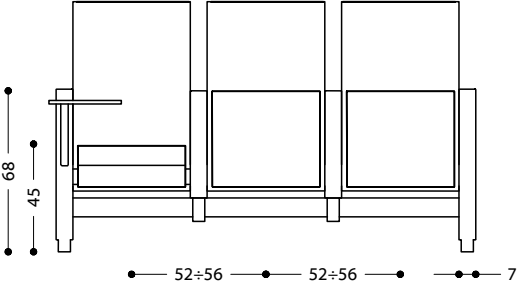
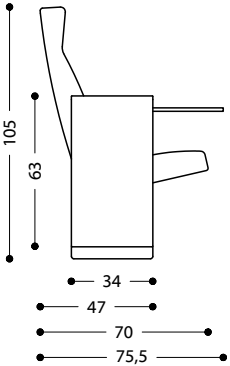

C100 with high backrest

