

C100 con respaldo bajo

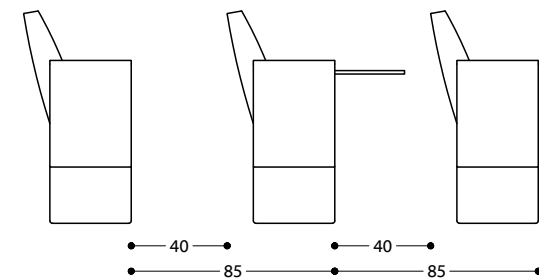

C100 con respaldo bajo + T200

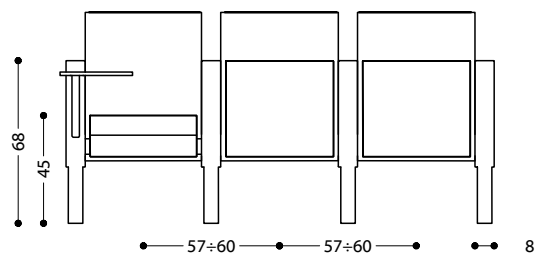
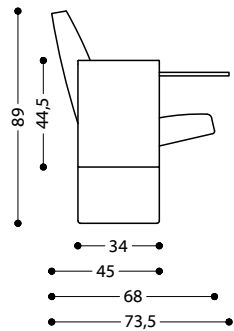
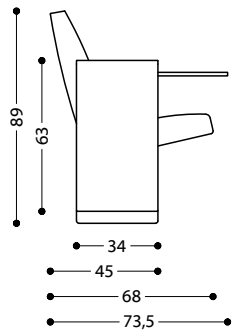
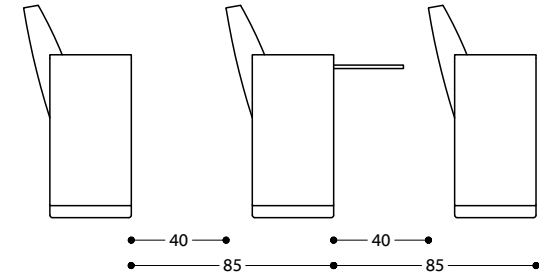
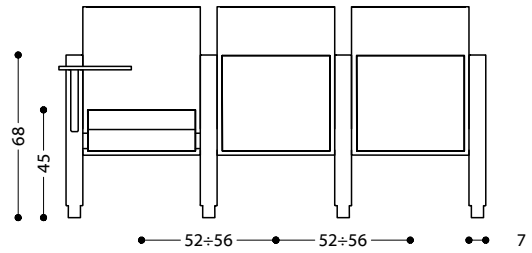
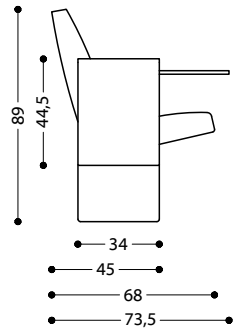
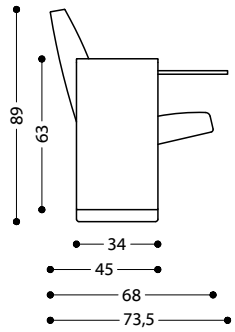
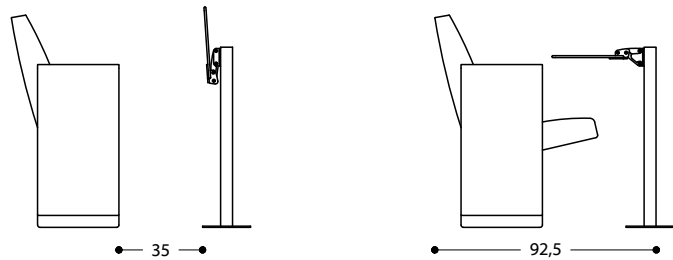
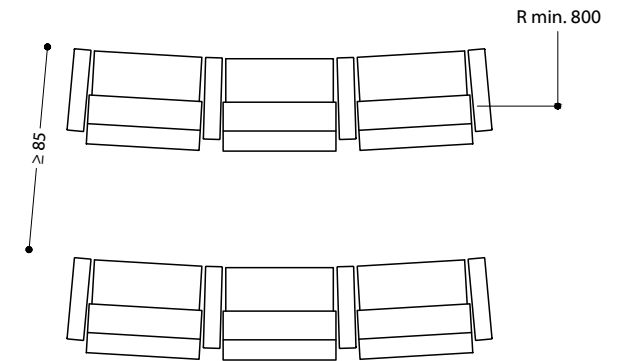
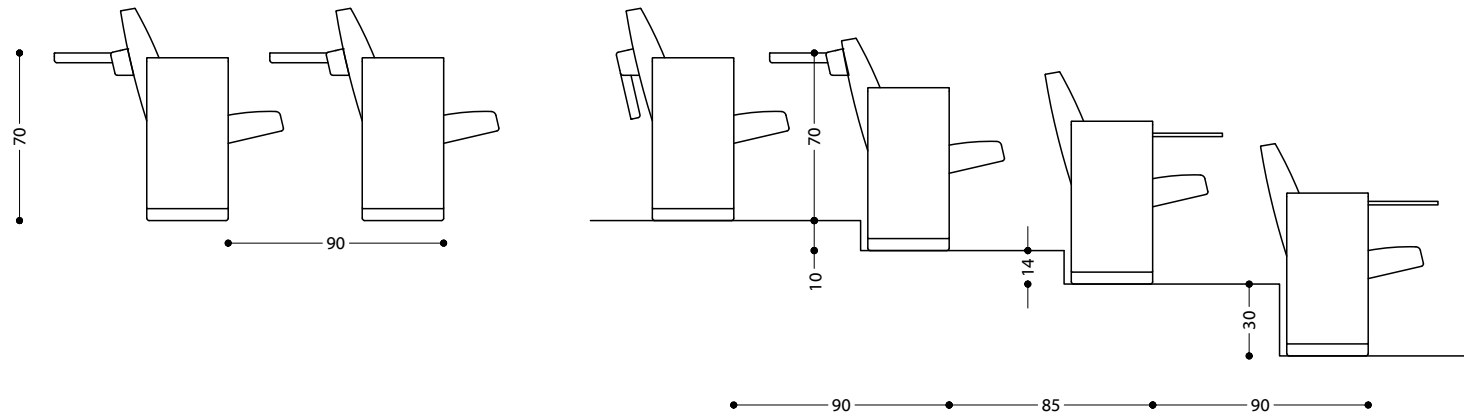

C100 con respaldo bajo

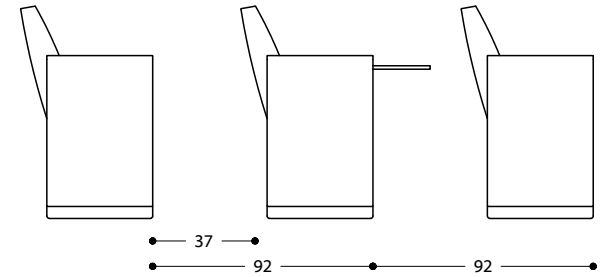
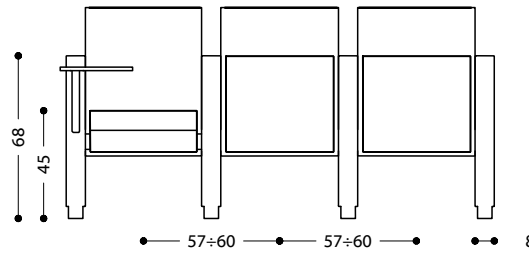
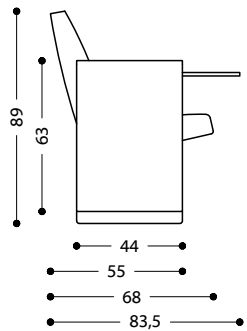
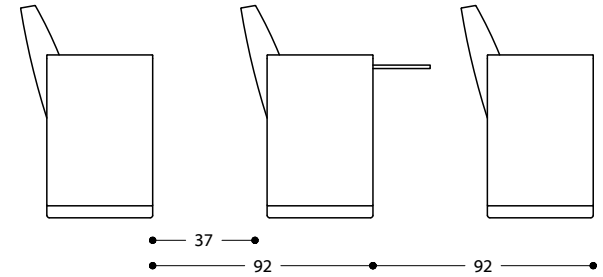
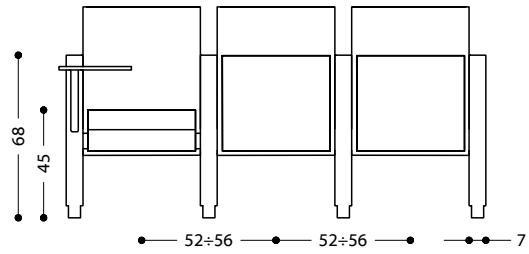
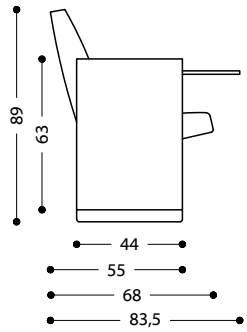

C100 con respaldo bajo

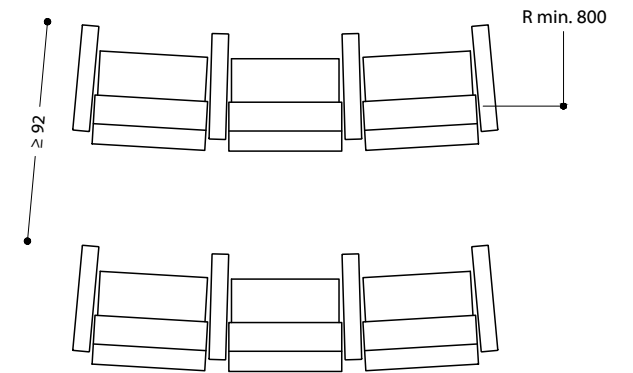
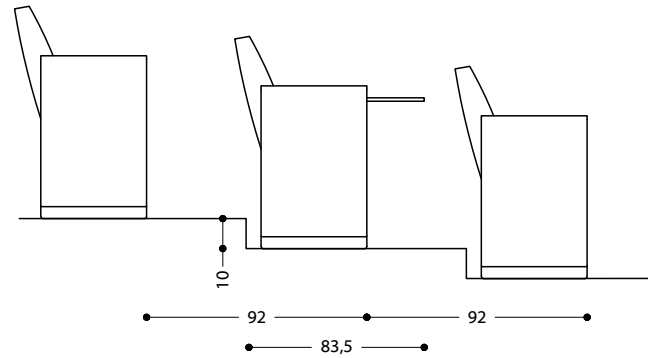

C100 con respaldo alto

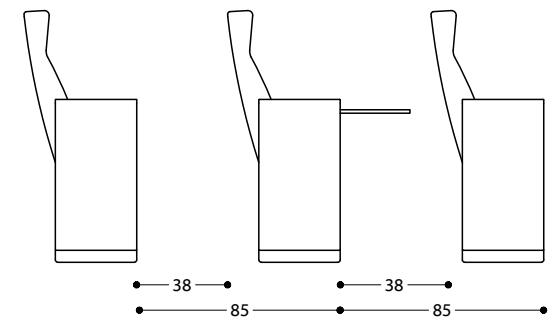
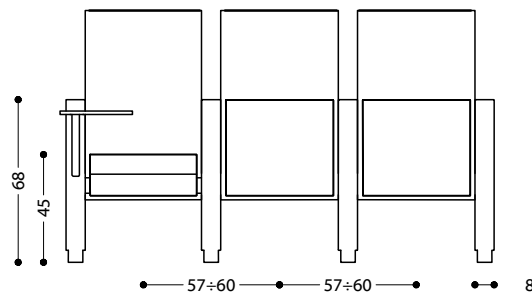
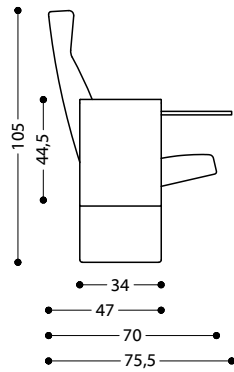
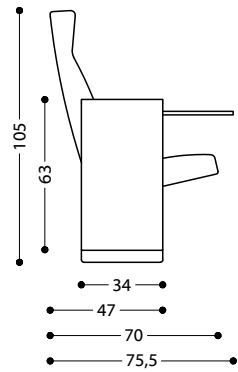
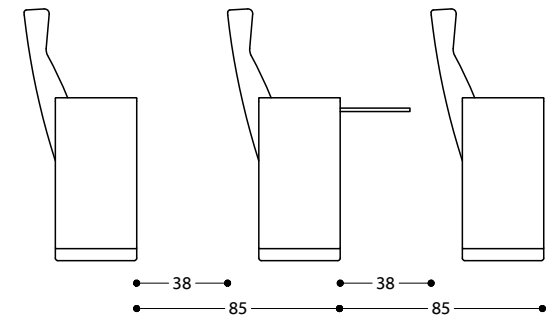
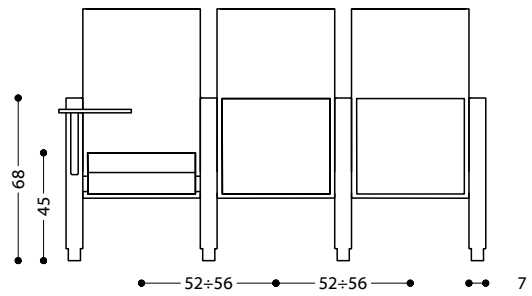
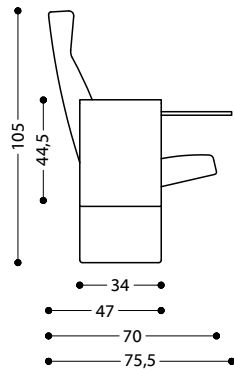
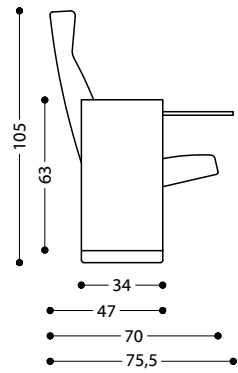

C100 con respaldo alto + T200

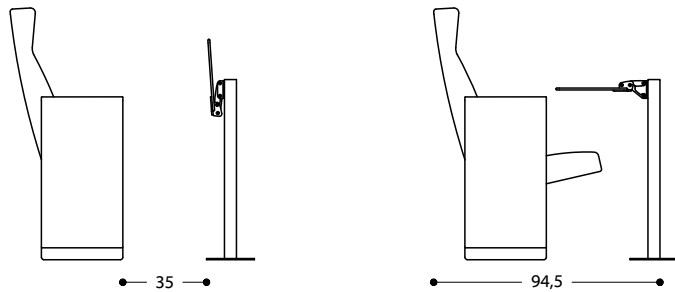
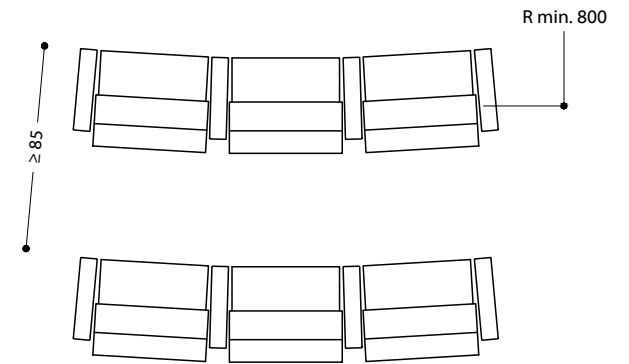
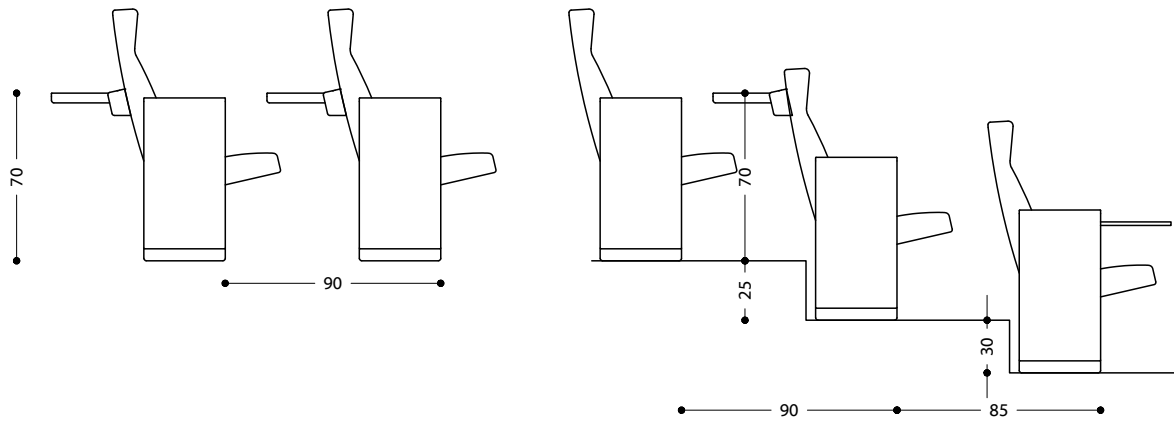

C100 con respaldo alto

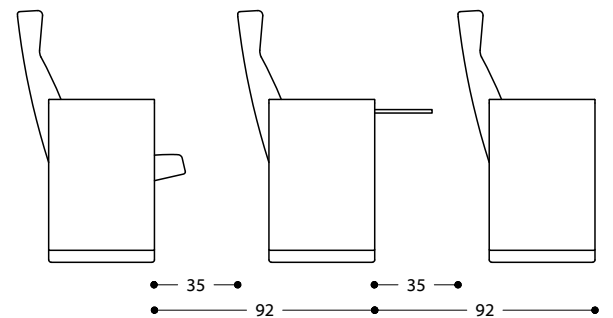
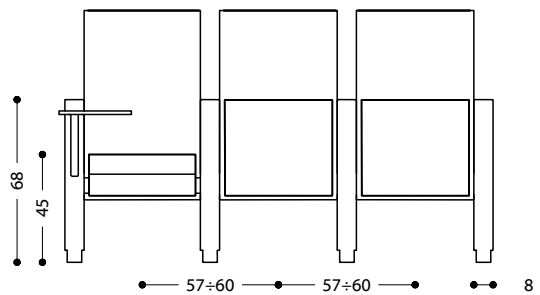
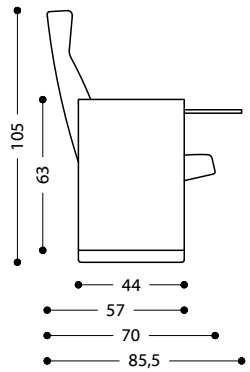
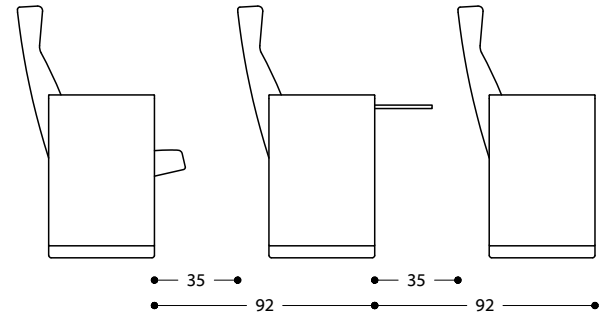
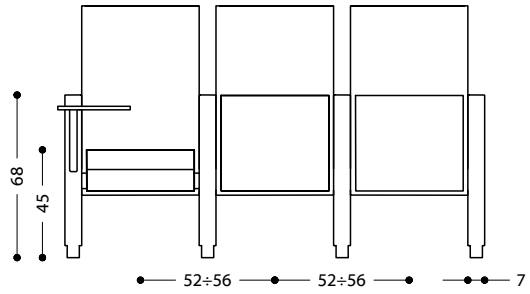
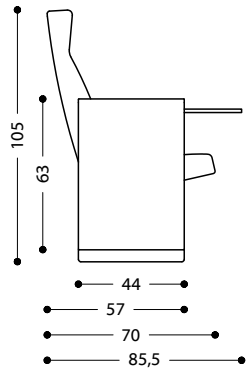

C100 con respaldo alto

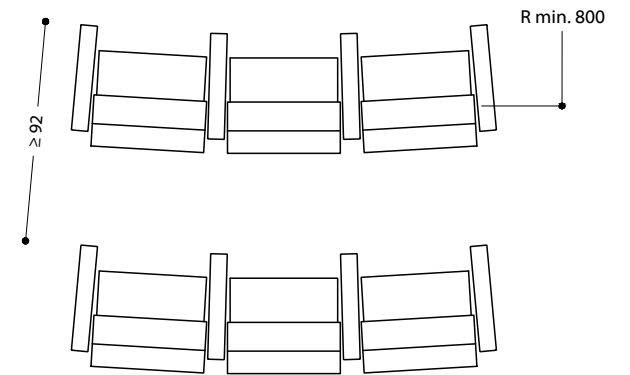
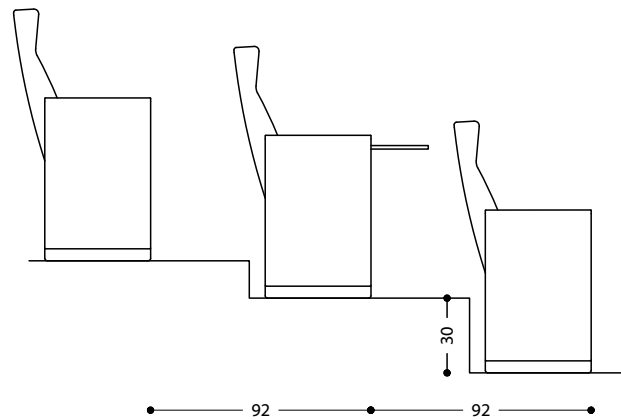

C100 con respaldo bajo

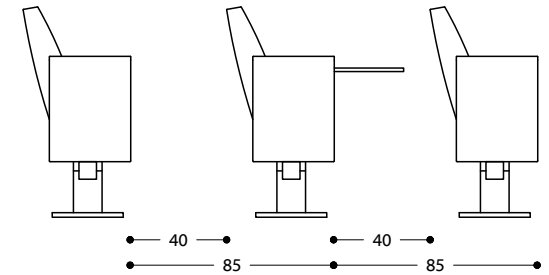
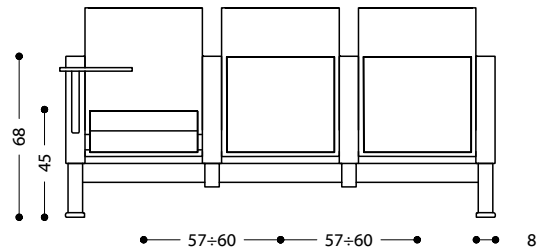
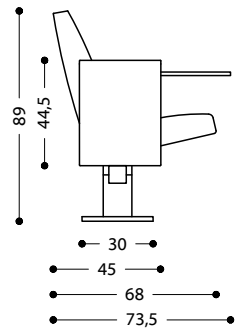
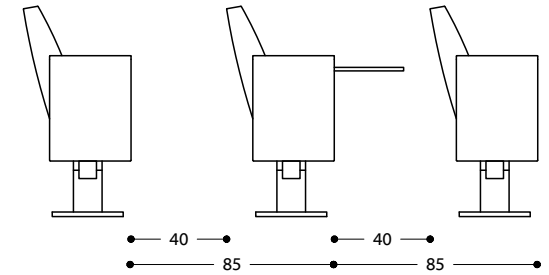
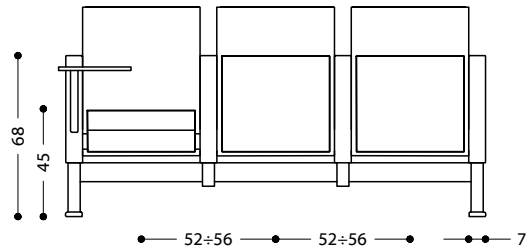
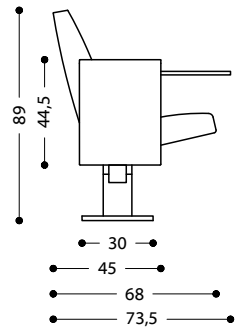

C100 con respaldo bajo + T200

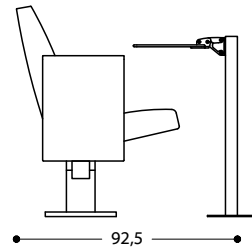
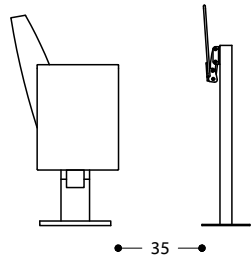

C100 con respaldo bajo

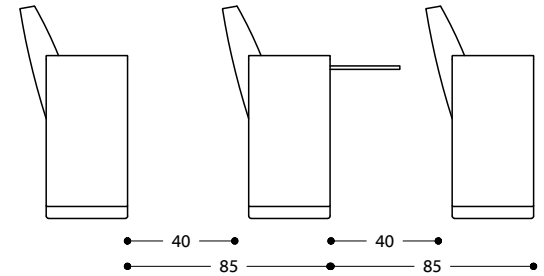
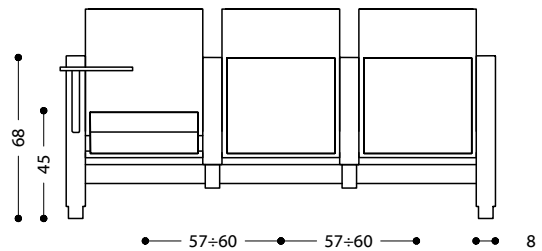
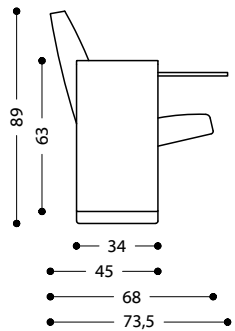
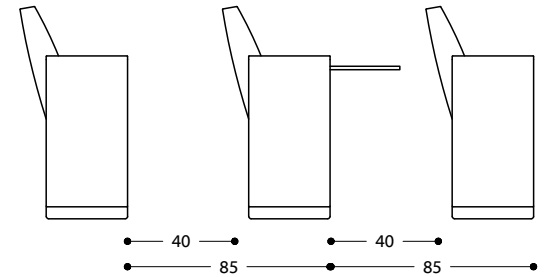
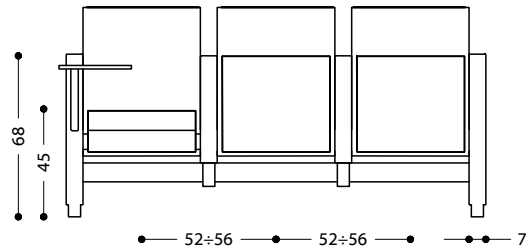
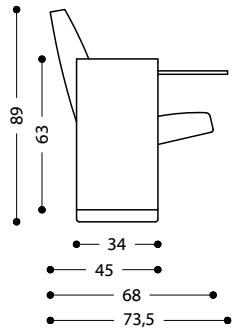

C100 con respaldo bajo

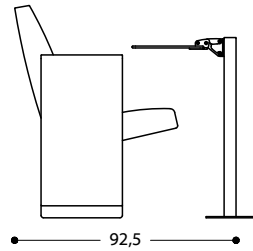
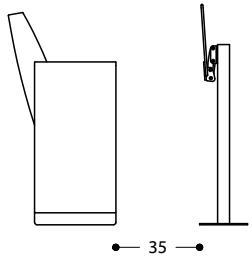

C100 con respaldo alto

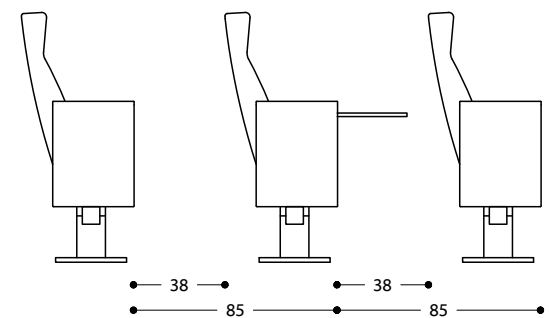
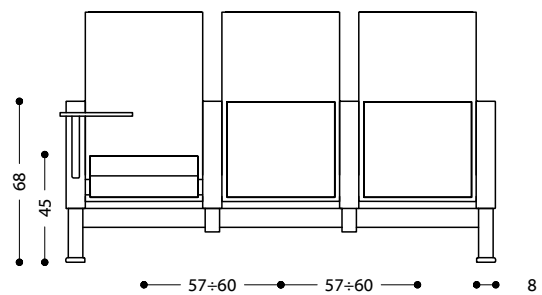
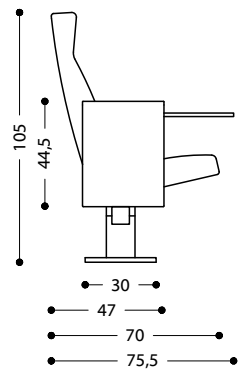
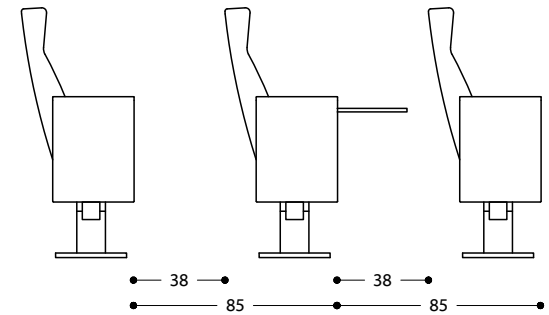
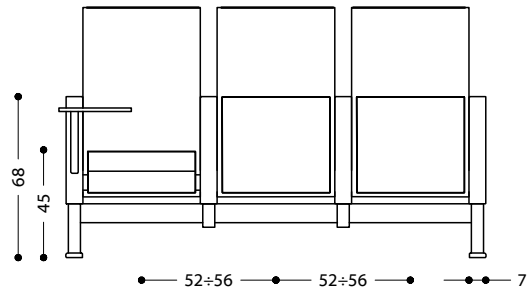
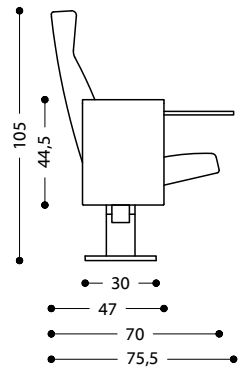

C100 con respaldo alto + T200

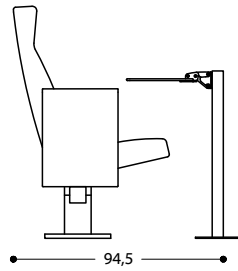
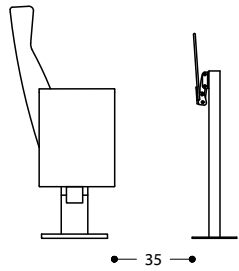

C100 con respaldo alto

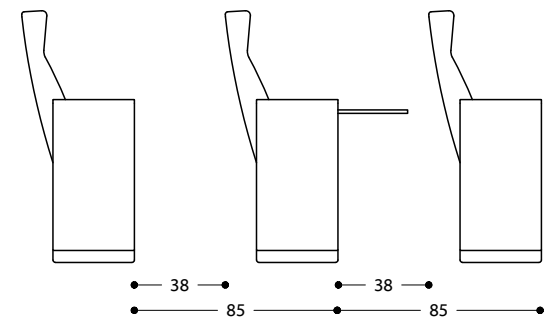
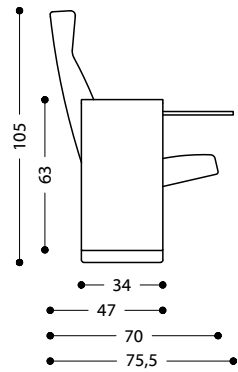
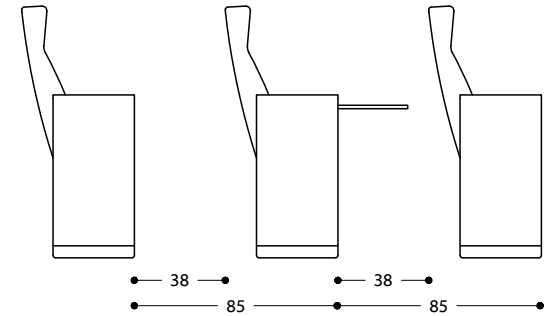
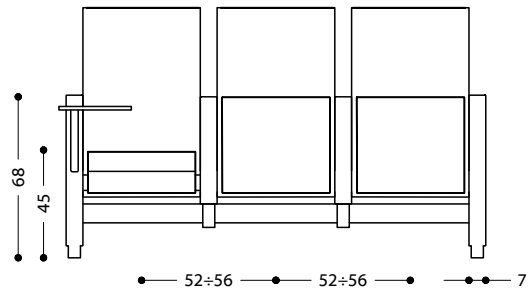
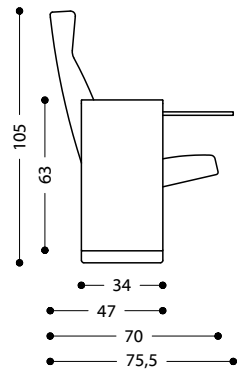

C100 con respaldo alto

