

C100 poltrona a schienale basso

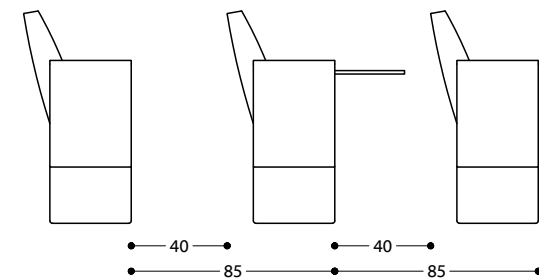

C100 poltrona a schienale basso + tavolino T200

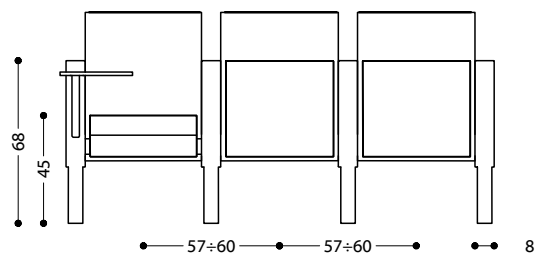
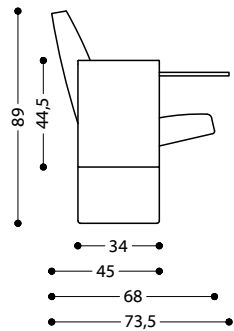
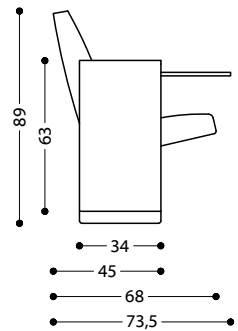
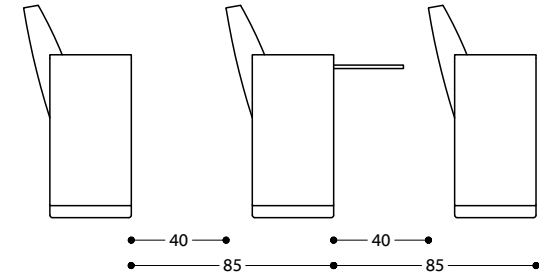
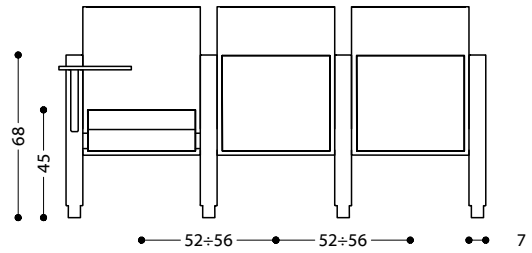
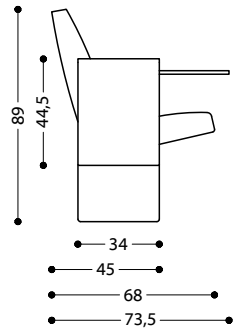
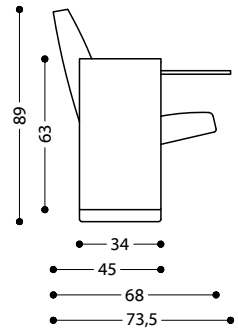
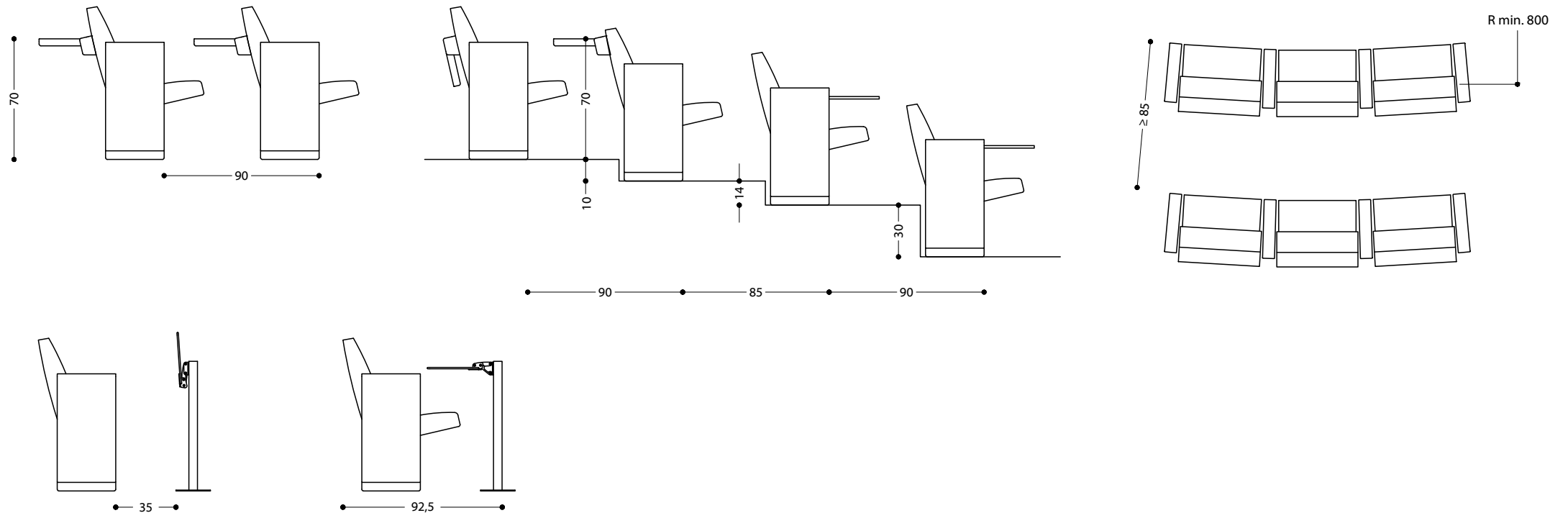

C100 poltrona a schienale basso

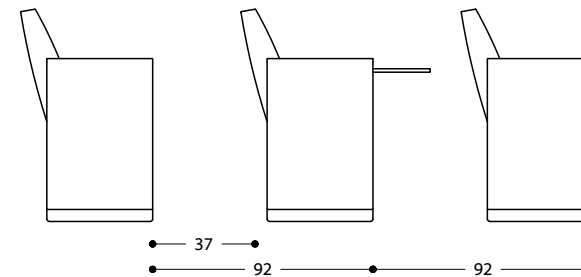
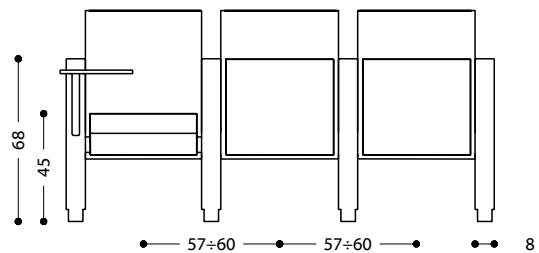
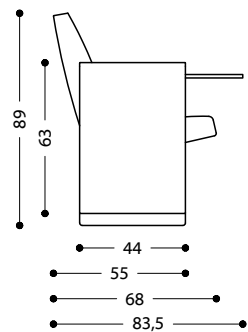
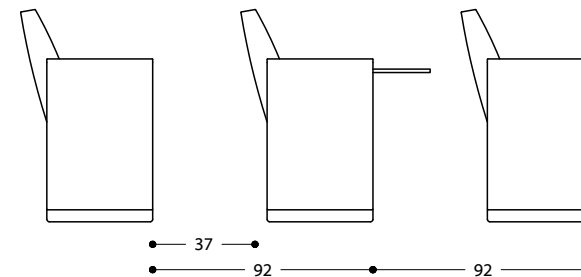
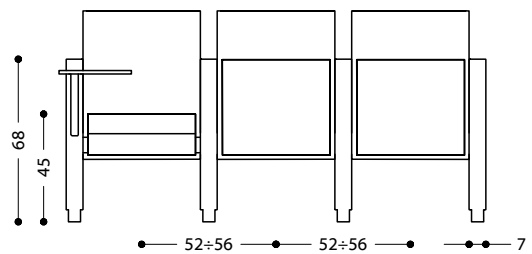
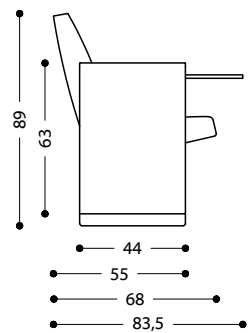

C100 poltrona a schienale basso

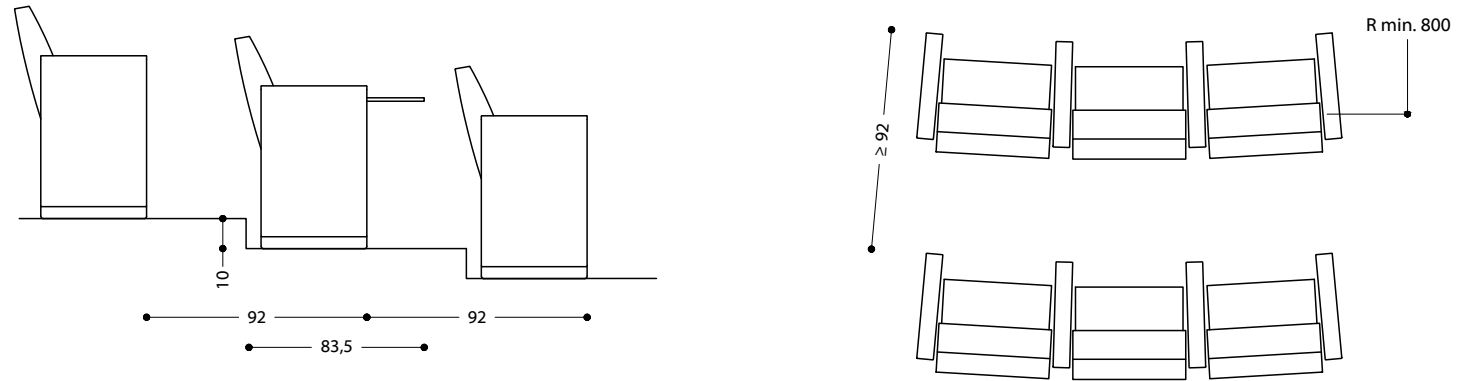

C100 poltrona a schienale alto

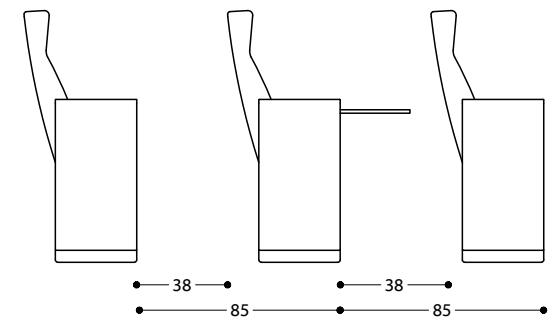
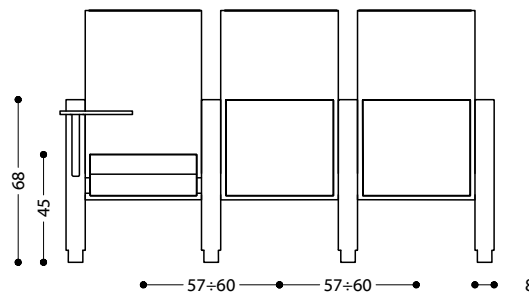
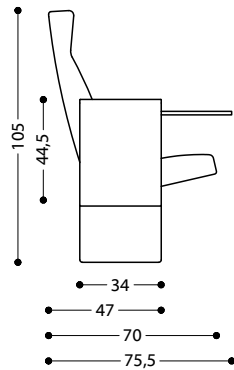
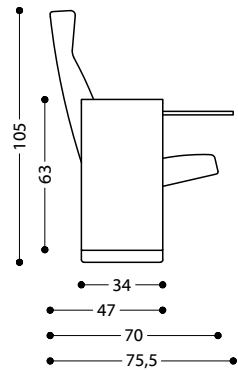
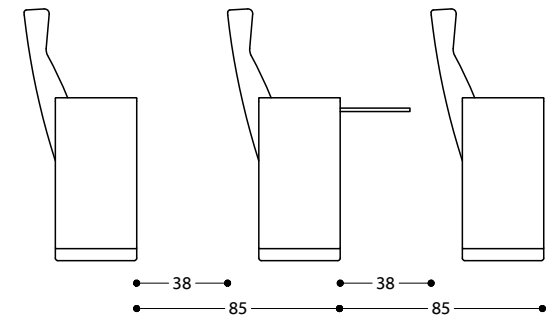
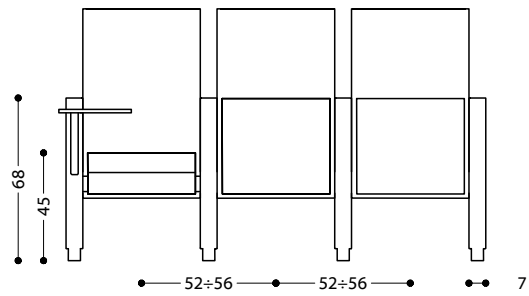
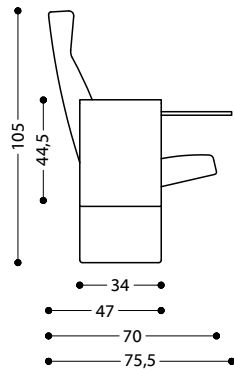
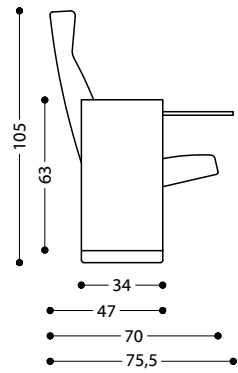

C100 poltrona a schienale alto + tavolino T200

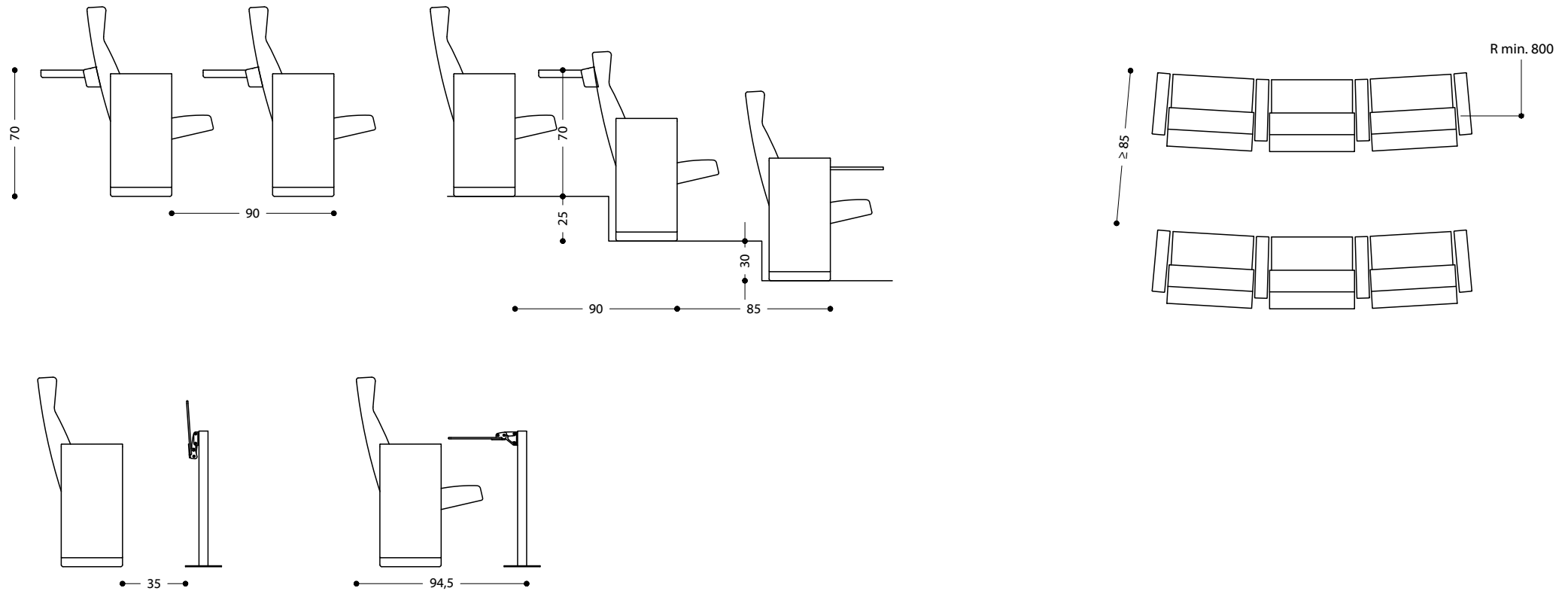

C100 poltrona a schienale alto

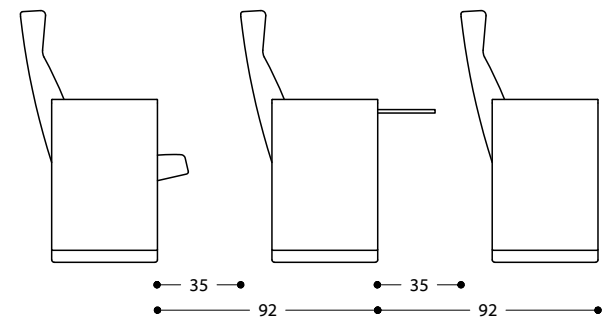
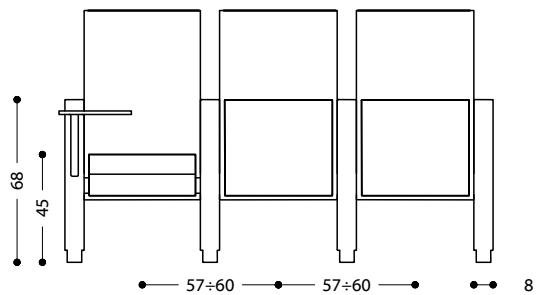
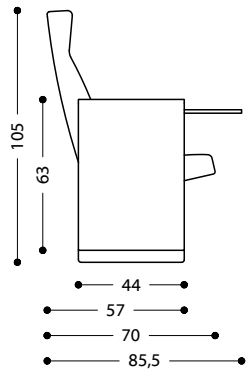
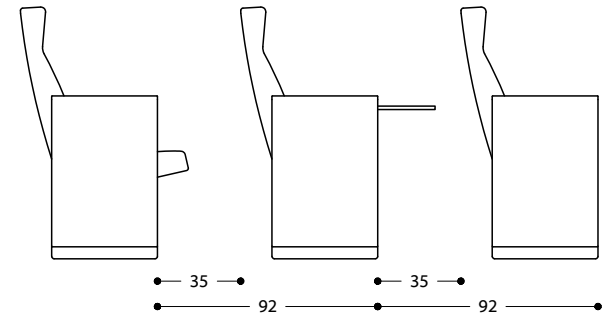
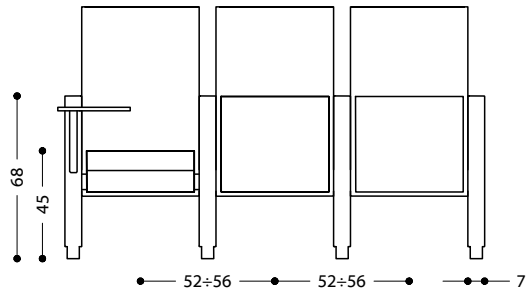
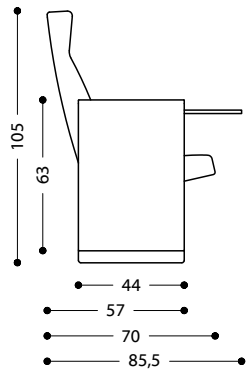

C100 poltrona a schienale alto

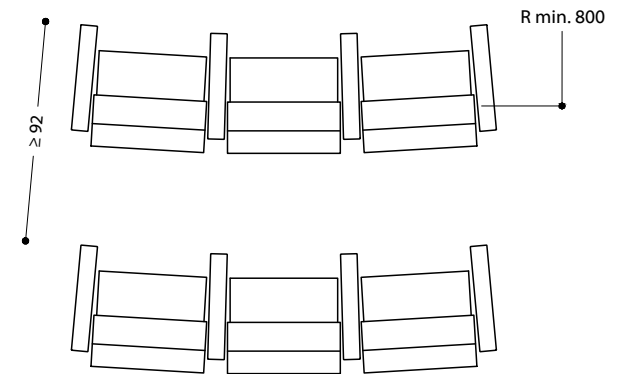
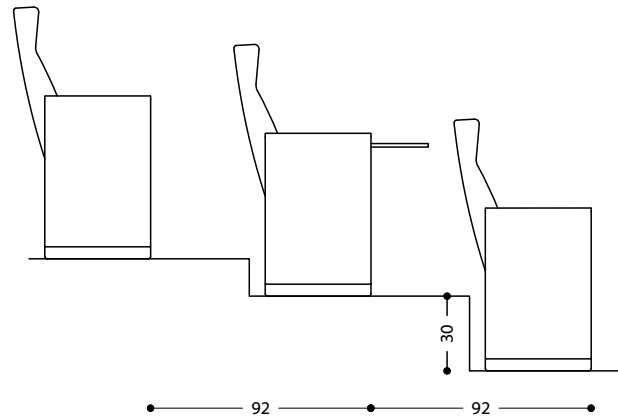

C100 poltrona a schienale basso

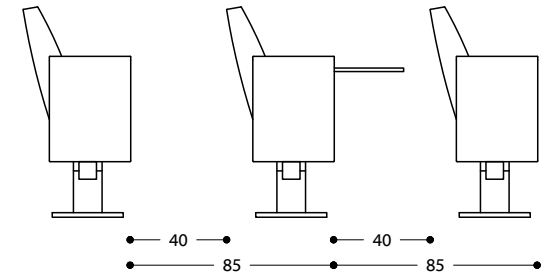
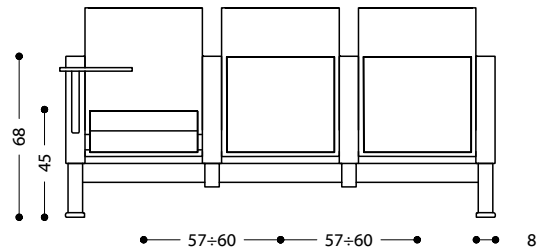
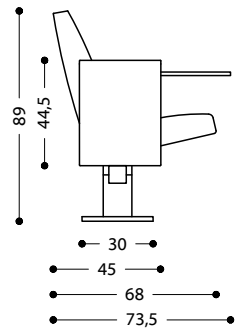
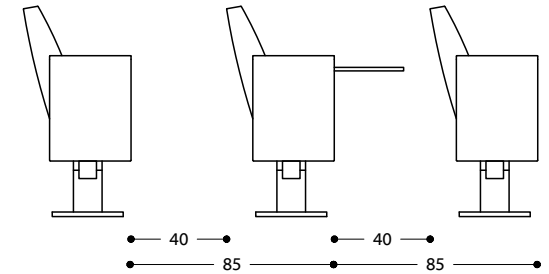
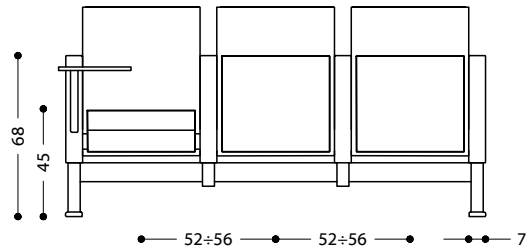
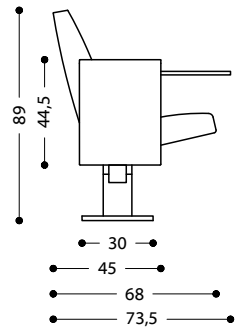

C100 poltrona a schienale basso + tavolino T200

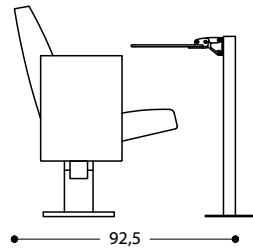
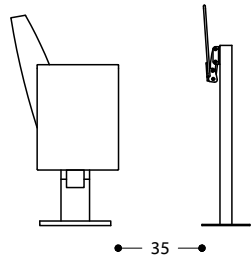

C100 poltrona a schienale basso

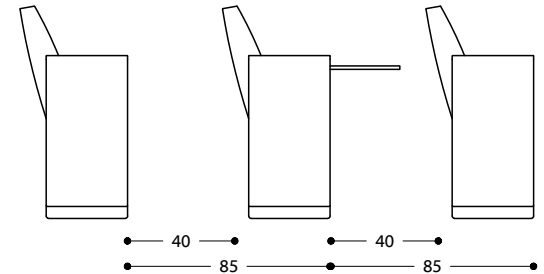
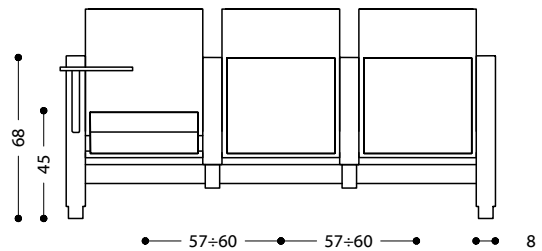
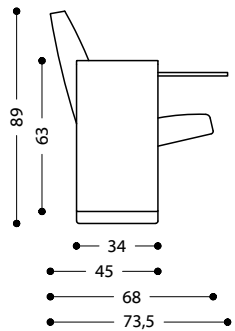
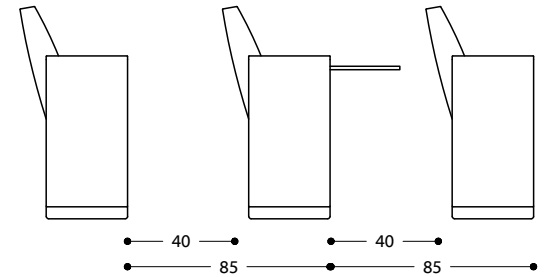
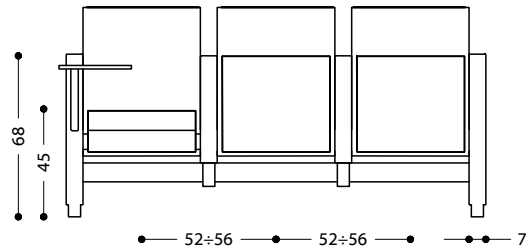
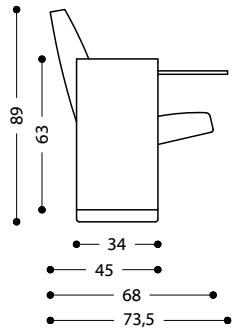

C100 poltrona a schienale basso

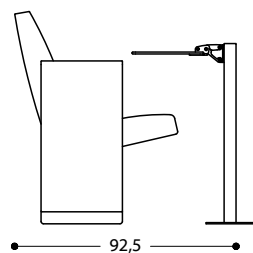
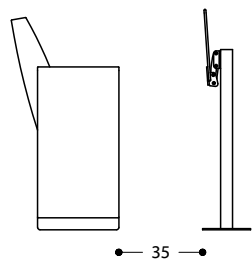

C100 poltrona a schienale alto

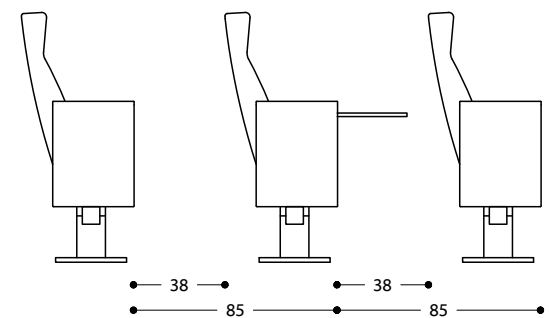
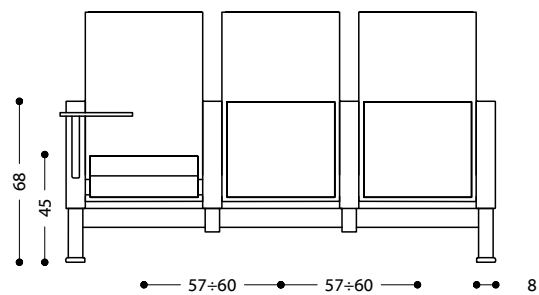
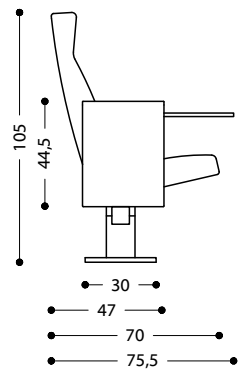
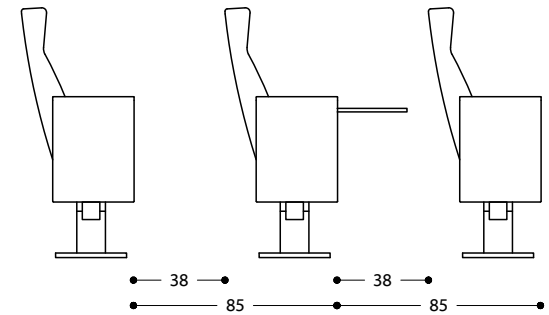
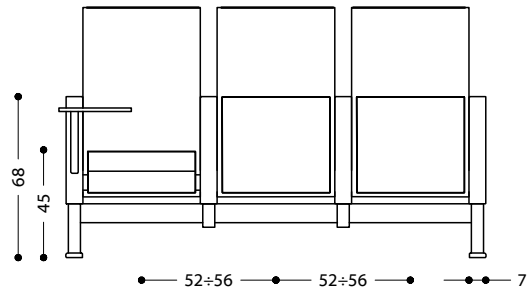
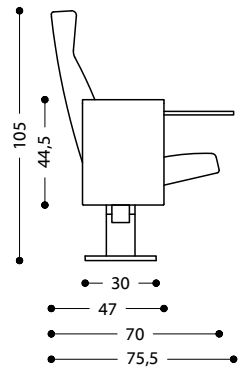

C100 poltrona a schienale alto + tavolino T200

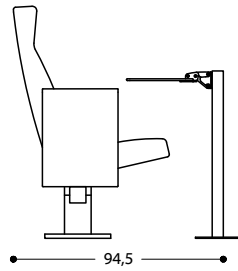
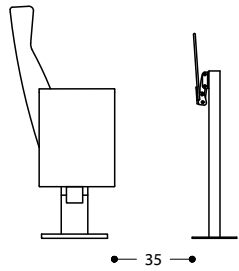

C100 poltrona a schienale alto

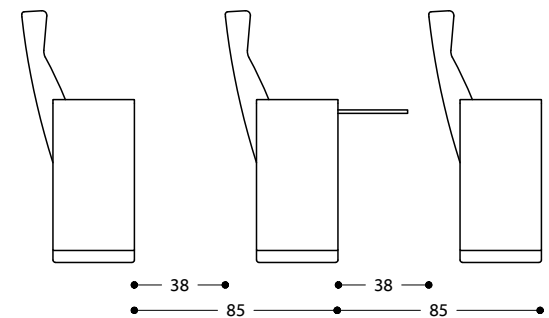
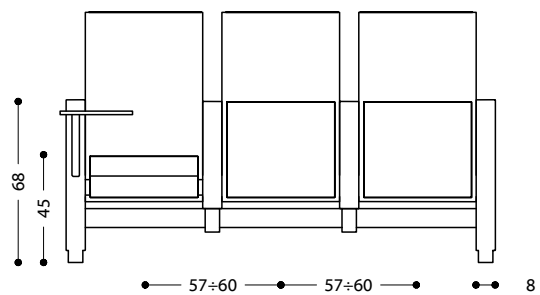
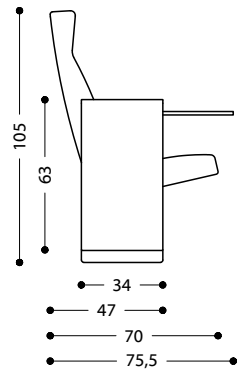
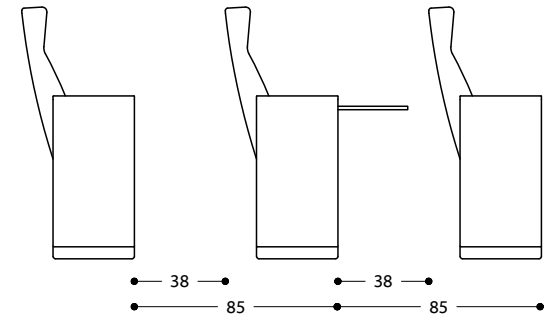
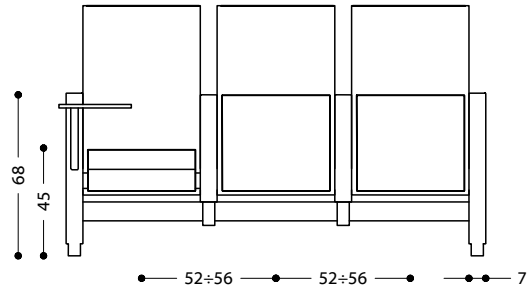
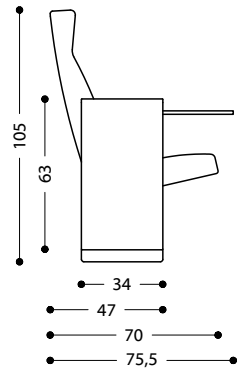

C100 poltrona a schienale alto

